

STUART TURNER LTD HENLEY-ON-THAMES.

THIRD ANGLE PROJECTION

DIMENSIONS IN MILLIMETRES

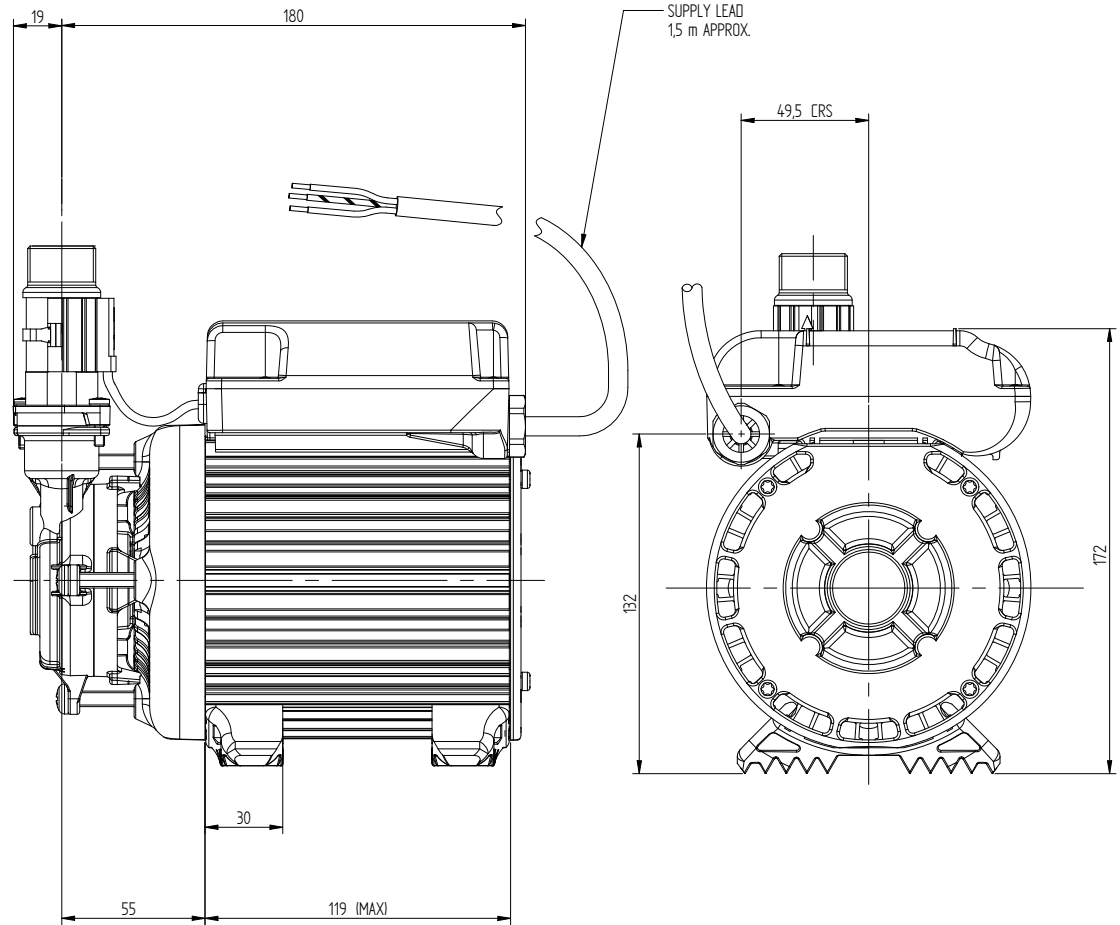
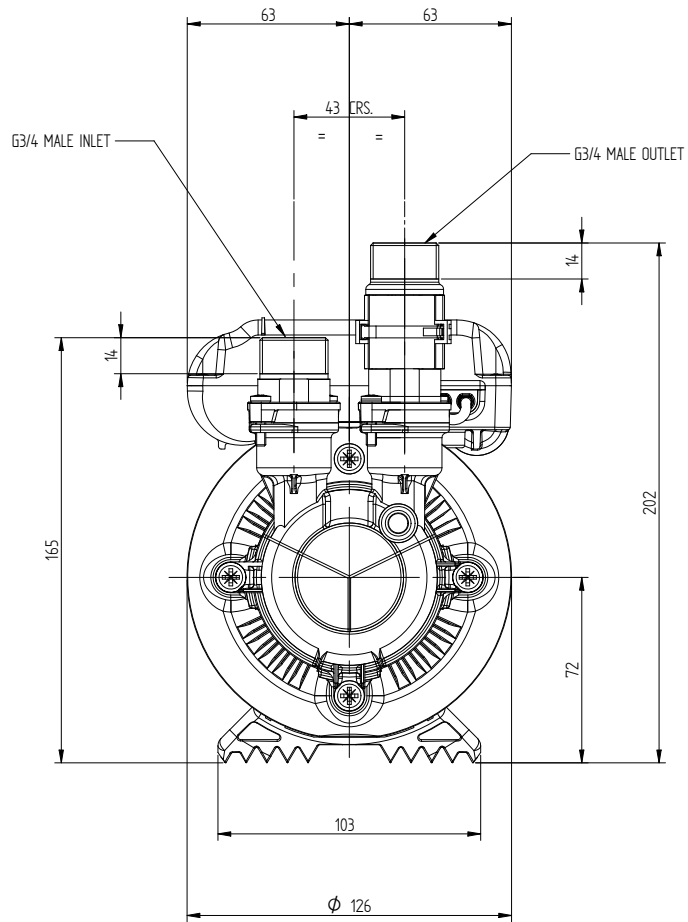

If drawing is to be used for constructional purposes please contact Stuart Turner Ltd and request a certified document.

Stuart Turner Ltd reserves the right to amend specifications without notice.

Stuart Turner Ltd own the copyright within this document. The document may be printed for personal use only. The document must not be altered, reproduced or utilized in any way without written permission from Stuart Turner Ltd, Henley-on-Thames, Oxon, UK.

GENERAL ARRANGEMENT OF A MONSOON STANDARD 2.0, 3.0 & 4.5 bar SINGLE

W41189

DATE: 01/10/09